



॥ सिद्धिः भूषयते विद्याम् ॥

**avantika**  
UNIVERSITY

**India's first Design Centered University**  
promoted by MIT Group of Institutions, Pune.

**UGC Approved**

# Index

1.	About Avantika University	1
2.	MIT Group	2
3.	Learning Pedagogy	3
4.	Schools at Avantika University	4
5.	User Experience Design	5
7.	Industrial Design	7
9.	Communication Design	9
11.	Computer Science & Engineering	11
13.	General Electives	13
14.	Master's Program	14
15.	Internship and Placements	15
16.	Students Achievements	16
17.	Batch Profile	17
18.	B.Des User Experience Design	21
19.	B.Des Industrial Design	24
20.	B.Des Communication Design	32
21.	B.Tech Computer Science and Engineering	39
22.	B.Tech Mechanical Engineering	43
23.	M.Des Industrial Design	45
24.	M.Des Communication Design	47



# About Avantika University

Avantika envisions creating agents of change by imparting in them a keen sense of social responsibility, analytical thinking and problem-solving skills. The University envisages a distinct learning environment where students are empowered to further apply their knowledge and skills to combat real-world challenges.



# MIT Group 37 Years of Legacy

- Established in 1983- The first engineering college in Maharashtra
- Presence across primary, secondary and tertiary education.
- Student Community represents cross section of India along with International
- 10+ Campuses in Maharashtra, Madhya-Pradesh and Meghalaya.

**70+**  
Institutions

**50,000+**  
Students

**3000+**  
Faculty

**100,000+**  
Alumni

# Learning Pedagogy

We are strong believers in the concept of **Designeering** = Design+Engineering, while also incorporating the business side of it to assist our students be future-ready.

- o Multidisciplinary approach
- o Integrative and Immersive learning
- o Liberal and creative approach
- o Project-based learning
- o Flipped classroom
- o Low student to faculty ratio

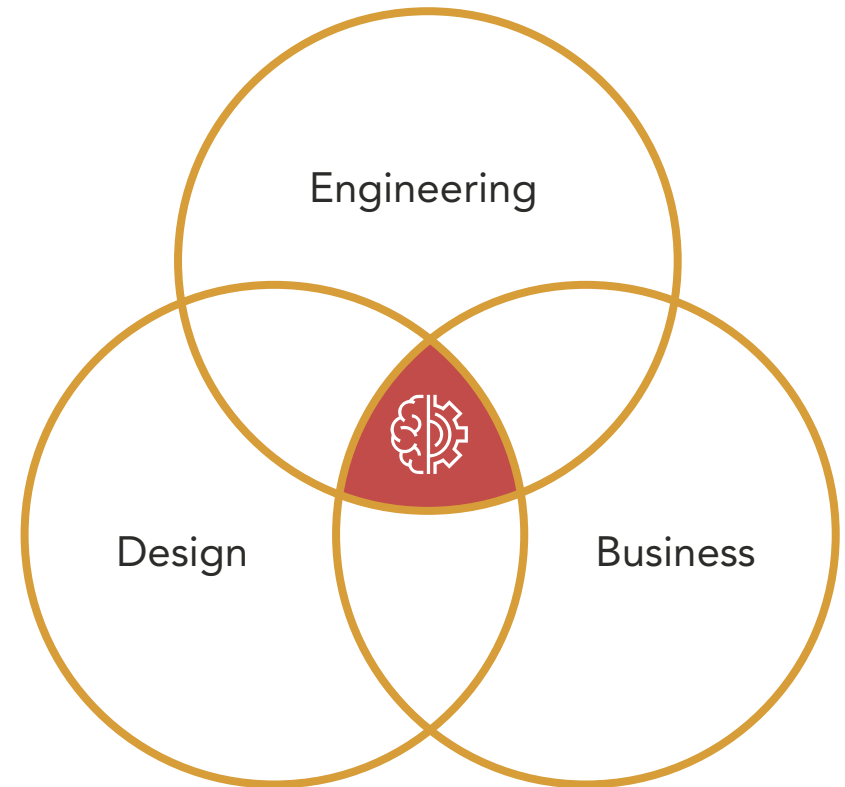

# Schools at Avantika University

Bachelor's Program : 4 Years Program (1-year foundation program + 3 years of specialization)

Master's Program: 2 Years Program



## School of Design

- o User Experience Design
- o Industrial Design
- o Communication Design

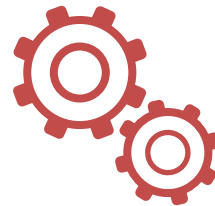

## School of Engineering

- o Computer Science & Engineering
- o Mechanical Engineering



## School of Fashion Design

- o Fashion Design



# User Experience Design

(B.Des)

A unique program that aims to introduce and expose students to a digital environment, enabling them to design contextual and personalized experiences, with user-centered research at its core.

## Important Courses

At Avantika University, students specializing in User Experience Design are introduced to the foundational principles of UX Design and with the use of right technologies they create meaningful and relevant experiences and acquaint themselves with the rigorous demands of the industry.

- o User Research Tools
- o User-Centered Design
- o Ergonomics
- o Business Research
- o Information Design
- o Interaction Design
- o Visual Design
- o Typography
- o Usability Testing



# Subjects

User Experience Design

---

- o Introduction to User Experience Design
- o Basics of Psychology
- o Business Research
- o Design Project: Simple Design
- o Information Architecture
- o Design Project: Re-Design
- o Introduction to Coding
- o New Media Design
- o Entrepreneurship
- o Design Project: Inventive Design
- o Testing Design
- o Design Project: Field Project



# Softwares Learnt

User Experience Design

---

- o Adobe XD
- o Adobe Illustrator
- o Adobe Photoshop
- o Sketch
- o Adobe After Effects



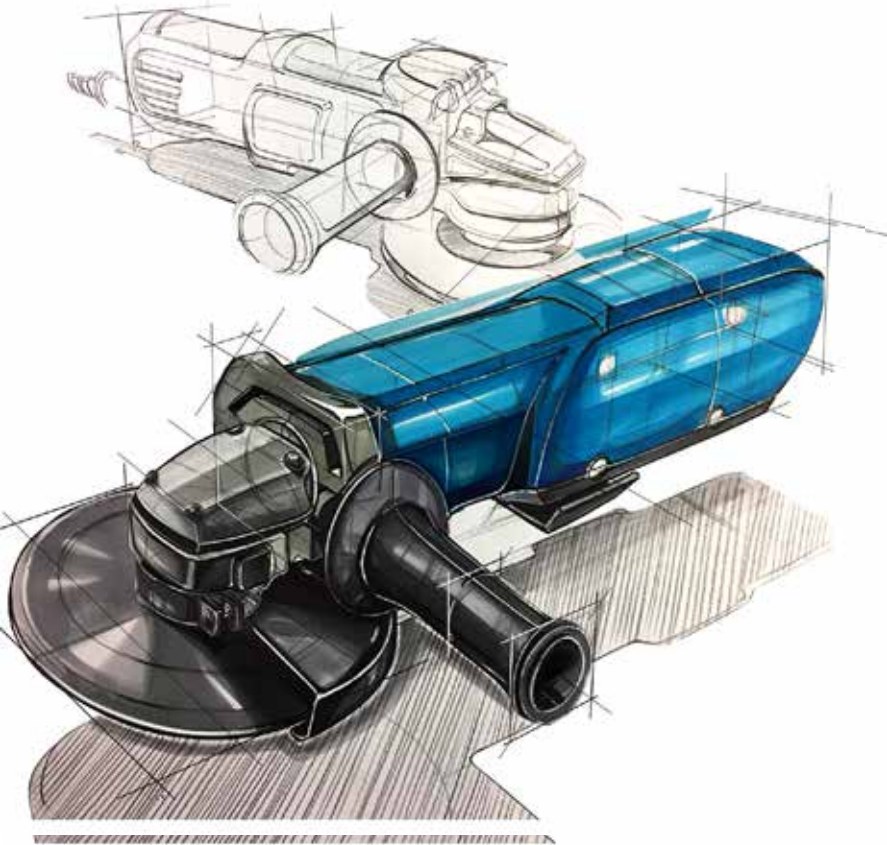

## Industrial Design

(B.Des and M.Des)

The Industrial Design program aims to equip and enable students to develop products and solutions through good design to solve real-world problems, with a core focus on human-centric design.

### Important Courses

At Avantika University, students of Industrial Design specialisation start with an observed need or an idea which is transformed through form, structure, color, material, texture, environment, and detailing to a digital and physical prototype. The outcome could be a product, an interaction, a space, or an experience which creates sustainable value and evokes a positive emotional response for the intended user.

- o Drawing/Rendering Skills
- o Creative Visualization and Thinking Techniques
- o Model making and Material Handling Skills
- o Form Development Techniques
- o Materials and Manufacturing Techniques
- o User Centered Approach
- o Ergonomics



# Subjects

Industrial Design

- Product Semantics
- Material and Form
- Typography and Branding Design
- Spatial Structures and Articulation
- Packaging Design
- Product Photography
- Advanced Manufacturing processes
- Entrepreneurship
- Design Methodology
- Design Research
- Human Machine Interface
- Design Management



# Softwares Learnt

Industrial Design

- Adobe InDesign
- Adobe Illustrator
- Adobe Photoshop
- Rhino
- Solidworks
- Keyshot



# Communication Design

(B.Des and M.Des)

An integrated program across different media which transcends visual expression and builds sensorial experiences. It creates new channels of communication and interfaces to address untapped needs for a positive change.

## Important Courses

At Avantika University students of Communication Design specialisation undergo a variety of courses with the right blend of traditional design theory and technology. Listed below are a few of the important courses for the Communication Design specialisation.

- o Typography
- o Branding
- o System Design
- o Information Visualisation
- o Packaging Design
- o Layout and Composition
- o Publication Design
- o Semiotics
- o Photography
- o Design Research
- o Social Communication
- o Design Management and Profession Studies

# Subjects

Communication Design

- o Communication Theory and Media Studies
- o Design Research
- o Introduction to User Experience Design
- o Design Project: Simple Design
- o Design Project: Advanced
- o Design Project: Re-Design
- o Design Project: Inventive Design
- o Digital Image-Making
- o Design Project: System
- o Design Project: Field
- o Design Project: Experimental
- o Entrepreneurship

# Softwares Learnt

Communication Design

- o Adobe InDesign
- o Adobe Illustrator
- o Adobe Photoshop
- o Adobe After Effects
- o Adobe Audition
- o Autodesk 3DS Max
- o Adobe Premiere Pro



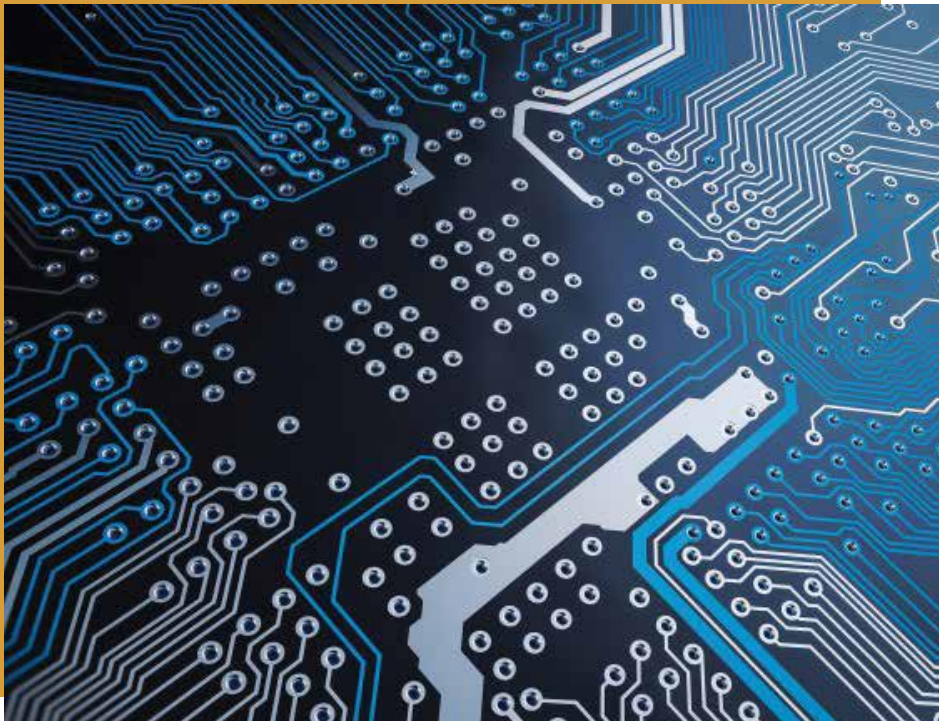

# Computer Science & Engineering

(B.Tech)

The Computer Science program follows a design-centered philosophy, with an interdisciplinary curriculum and experiential learning at the core. The curriculum imbibes problem-solving, to meet the current and future needs of the technology era.

## Important Courses

At Avantika University, students of Computer Science specialisation apply the principles of engineering, computer architecture, software engineering and signal processing to understand and synthesize such systems. The engineering aspirants will combine creative and analytical skills to craft an idea into reality.

- o Artificial Intelligence
- o Cloud Computing
- o Machine Learning
- o Data Analytics
- o Engineering Computing
- o Internet of Things (IoT)
- o Cyber Security
- o Interaction Design
- o UI-UX Design
- o Computer Networks



# Subjects

---

Computer Science & Engineering

- Engineering Mathematics
- Engineering Physics
- Business Research
- Principles of Engineering
- Data Structures
- Discrete Mathematics
- Computer Architecture
- UI Design
- Algorithms
- Introduction to User Experience Design
- Joy of Electronics
- Computer Graphics
- Operating System
- Object-Oriented Programming (C++)

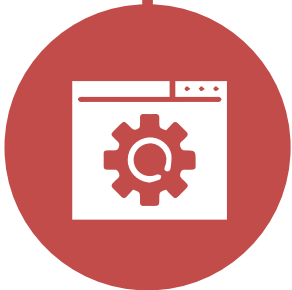

# Technologies Learnt

---

Computer Science & Engineering

- JavaScript
- C++
- Python
- Wordpress
- MATLAB
- Linux
- Raspberry Pi
- CSS
- HTML
- PowerShell
- MySQL
- PHP

# General Electives

In addition to the core courses offered in every specialisation, students of Avantika University get to pursue a general elective out of a wide range of choices. These electives offer students across all specialisations to work together in a multi-disciplinary environment, honing their skills and exposing them to alternative disciplines and viewpoints.

- o Sustainable Design
- o Universal Design
- o Furniture Design
- o Automobile Accessory Design
- o Design with Natural Materials
- o Design for Six Sigma
- o Narratives and Storytelling
- o Exhibition Design
- o Social Communication
- o Environmental Graphics
- o Immersive Media Design
- o Game Design
- o Artificial Intelligence Foundation
- o Machine Learning Foundation
- o Data Analytics Foundation
- o Electric Vehicles
- o Digital Product Design

# Master's Program

---



The Master's program at Avantika is based on a design-centered curriculum with a philosophy of interdisciplinary education. The curriculum, along with a major field of specialization, is complemented with the flavour of a minor. The major provides in-depth domain knowledge while the introduction of minors will provide an opportunity for cross-disciplinary learning.

An industry internship and a capstone project is an essential module to cap the integrated experience.

Avantika offers 2-year, residential programs in the domain of Design with different specializations.

- o Master of Design (M.Des)- **Communication Design**
- o Master of Design (M.Des)- **Industrial Design**



# Internship and Placements

---



*and many more.....*

# Achievements



Sahil Jain selected as a part of the **Young Designers Circle** core team of **WDO**



Avantika University wins 1st place **NASSCOM Design4India Awards** 2019 Immersive Design category



Soham Mohanty adjudged winner of the **Lexus Design Awards** 2020 in the Conceptual Category



Avantika University wins 2nd place **YUJ UXplorer Design Awards** 2019



**Ferona Fashion Night** the first androgynous fashion show in India as a collaboration between our fashion students and models from the LGBTQ community



Head to our Behance profile <https://www.behance.net/avantikauni> to view our students' work!

# Batch Profile

# Student Diversity Ratios B.Des

---

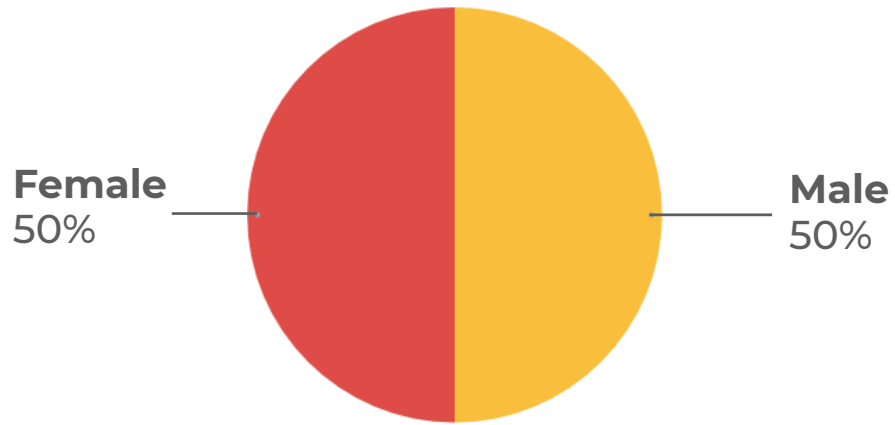

**B.Des User Experience Design**  
5(Female):5(Male)

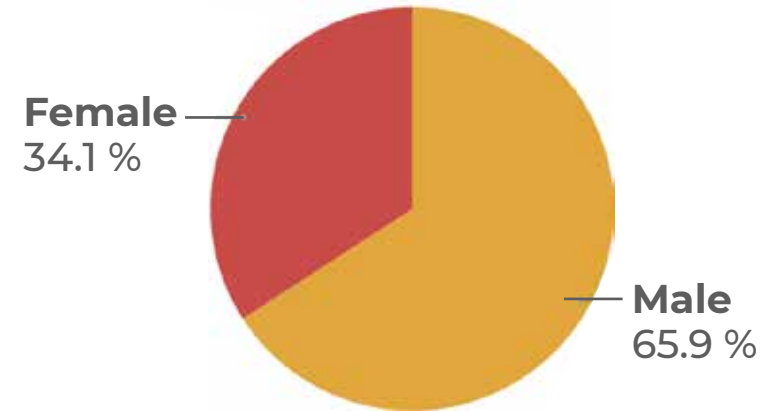

**B.Des Industrial Design**  
14(Female):27(Male)

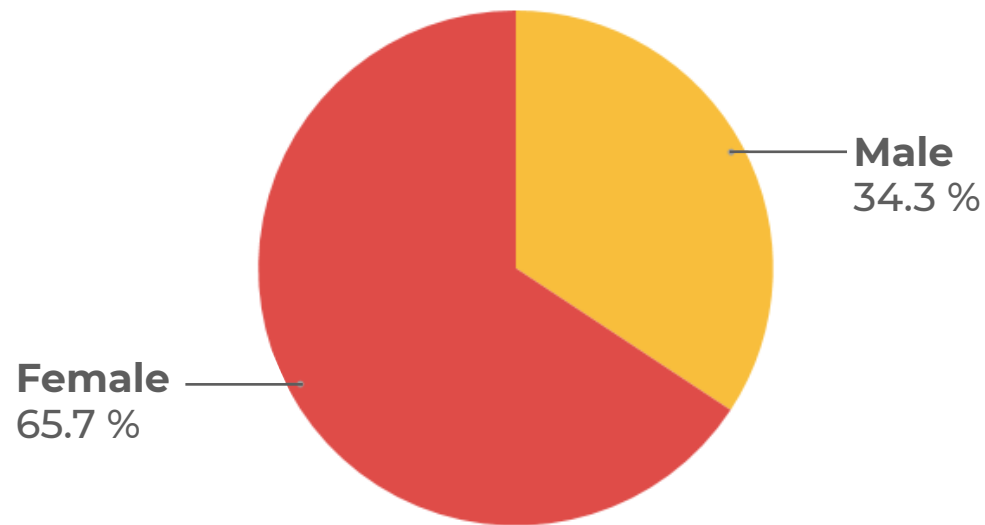

**B.Des Communication Design**  
23(Female):12(Male)

# Student Diversity Ratios B.Tech

---

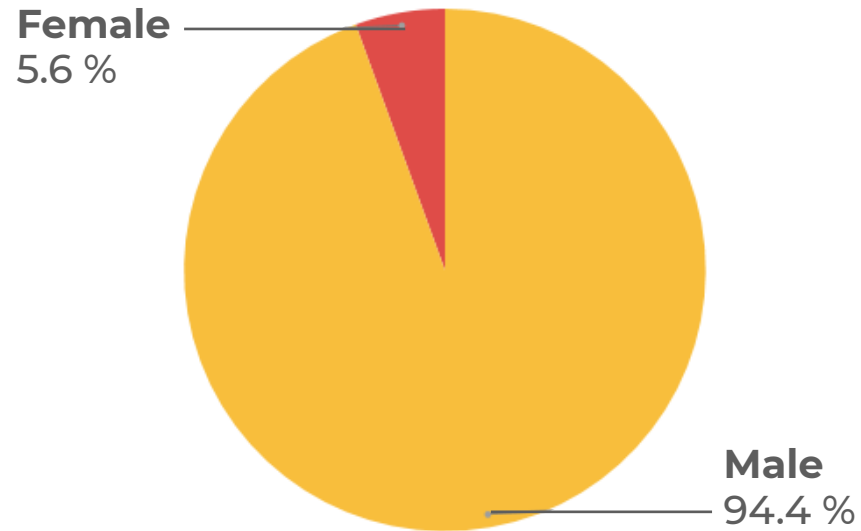

**B.Tech Computer Science & Engineering**

1(Female):17(Male)

Male  
100 %

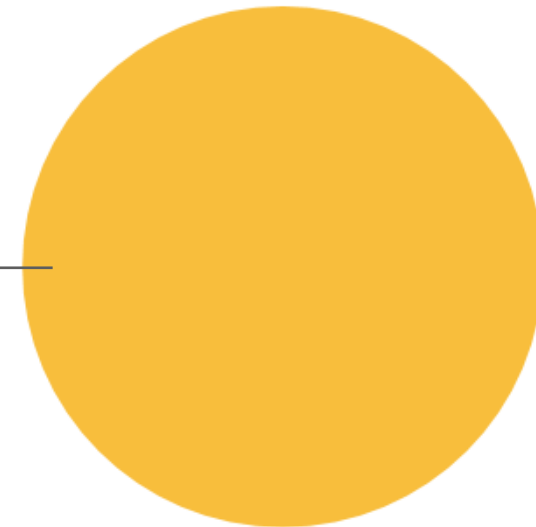

**B.Tech Mechanical Engineering**

3 Males

# Student Diversity Ratios M.Des

---

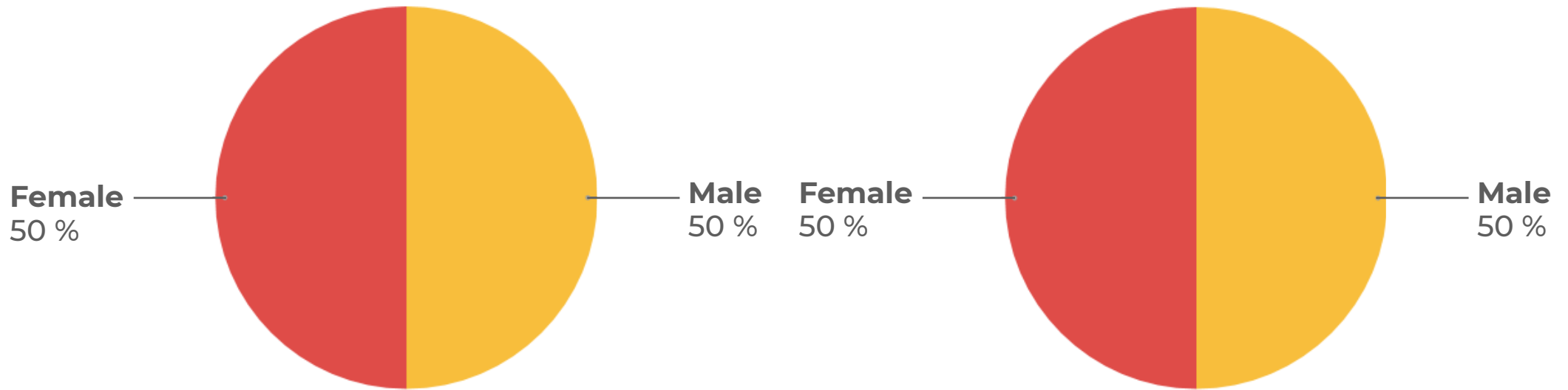

**M.Des Industrial Design**  
**3(Female):3(Male)**

**M.Des Communication Design**  
**3(Female):3(Male)**

---

# B.DES USER EXPERIENCE DESIGN

---

ALL THE 'PORTFOLIO LINKS' ARE HYPERLINKED

# Avi Choukhany



B.DES USER EXPERIENCE DESIGN

## Portfolio

<https://www.behance.net/avichoukhany>

## Internship

upGrad, Mumbai

- Worked on web redesigning, introduced brand visual identity and did extensive UX research.

# Chinmay Garg



B.DES USER EXPERIENCE DESIGN

## Portfolio

<https://www.behance.net/ChinmayGarg>

## Internship

Cynexis, Indore

- Building the information architecture and wireframes from scratch for the client in the gym sector.

# Dipanshu Singhall



B.DES USER EXPERIENCE DESIGN

## Portfolio

<https://www.behance.net/dipanshusinghall>

## Internship

upGrad, Mumbai

- Re-blog representations with appropriate research, identifying Pain points, identifying personas, redesigning blog layout, worked on information hierarchy.
- Branding Visual Identity (Did research and created brand guide)

## Professional Achievements

Featured in Mans World Magazine, August 2020 Issue.

# Divya Ray



B.DES USER EXPERIENCE DESIGN

## Portfolio

<https://www.behance.net/raydivya75263>

## Internship

CaratLane- A Tanishq Partnership, Mumbai

- Worked with different design teams for creating an effective and timeless store and online experience.
- Worked as a UX researcher where I got an opportunity to conduct various interviews and mapped out the insights which helped me in building an effective experience.

# Harshit Karir



B.DES USER EXPERIENCE DESIGN

## Portfolio

<https://www.behance.net/karirharsh3732>

## Internship

Indigo Consulting, Mumbai

- Worked on multiple PWA [web applications] regarding NEO banking for post-COVID environment
- Worked on 10+ client-based projects which involved user research, building strategies and creating prototypes
- Designed UI for multiple platforms

# Hetvi M. Shah



B.DES USER EXPERIENCE DESIGN

## Portfolio

<https://www.behance.net/hetvimahes0539>

## Internship

Indigo Consulting, Mumbai

- Successfully worked on 15+ client-based projects which involved user research, building strategies and creating prototypes.

## Professional Achievements

- Lexus Design Award India 2020-Finalist for project BloodXS.
- NASSCOM - Design4India 2018- Finalist for project BloodXS.



# Sahil Jain



B.DES USER EXPERIENCE DESIGN

## Portfolio

<https://www.behance.net/sahiljainn>

## Internship

Reliance Jio, Mumbai

- I was a part of the JioFiber team and worked on JioPhone, JioSTB and JioAppStore projects.
- I was also responsible for co-designing the JioDevelopers website and Hamleys website for Reliance Brands.

## Professional Achievements

Representing India in the World Design Organization (WDO)™ for Young Designer's Circle.

# Sanika Patwardhan



B.DES USER EXPERIENCE DESIGN

## Portfolio

<https://www.behance.net/sanikapatwardhan0799>

## Internship

Connexis Technologies, Pune

- I got to work on various domains such as healthcare analytics, dashboard UI design for Bennett and Coleman Group (Times of India Group).
- Branding and website design for Cloud Authority.
- Worked for my major project on Fitness Analytics Application for which I got to work on User research, Information Architecture and Wireframing.

# Tanishq Dalvi

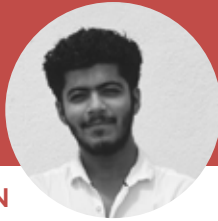

B.DES USER EXPERIENCE DESIGN

## Portfolio

<https://www.behance.net/tanishqdalvi>

## Internship

The Minimalist, Mumbai

- Designed the architecture and wireframes of the websites from the scratch under the domains of finance and health-tech (voice-control)
- Designed the visual interface and icons for the health-tech (voice-control) product website.

# Tanvi Joshi



B.DES USER EXPERIENCE DESIGN

## Portfolio

<https://www.behance.net/tanvijoshi1599>

## Internship

The Minimalist, Mumbai

- Responsive design of the websites for companies in fintech and voice technology industries.
- Consistent one on one communication for presentation and feedback on designs with the client.

## Professional Achievements

- Attendee & College Representative at Israel EdTech Summit 2018

---

# B.DES INDUSTRIAL DESIGN

---

ALL THE 'PORTFOLIO LINKS' ARE HYPERLINKED

# Aishwarya Chawla



B.DES INDUSTRIAL DESIGN

## Portfolio

<https://www.behance.net/aishwaryac782e>

## Internship

Connexis Technologies, Pune (UI/UX intern)

- Healthcare application
- Dashboards for Bennette Coleman
- Rebranding, and website design for cloud authority and fitness IoT platform where I enhanced the user experience by evaluating, wireframing, and prototyping.

# Aman Soni



B.DES INDUSTRIAL DESIGN

## Portfolio

<https://www.behance.net/asoni3008>

## Internship

Indigo Consulting, Mumbai (User Experience Intern)

- Worked on enhancing the digital experience of several foreign fin-tech brands.
- Reviewing and supplemented the online buying experience for top Indian e-commerce and pharmaceutical companies.

# Apoorva Balasundaram



B.DES INDUSTRIAL DESIGN

## Portfolio

<https://www.behance.net/apoorvaab>

## Internship

Rural Handmade, London

- Commissioning design ideas for work from home-based furniture.
- To write a technical paper on Design for Sustainability- exploring different trends using sustainable materials in the handmade industry.

## Professional Achievements

- Art installation at Kala Ghoda Art Festival- 2020 (Group Project)

# Atharva Pardeshi



B.DES INDUSTRIAL DESIGN

## Portfolio

<https://www.behance.net/atharvades9bba>

## Internship

Touchmagix Media Pvt. Ltd. , Pune

- Created 20+ arcade game concepts including floor games which are ready for prototyping, will be in the market soon.

## Professional Achievements

- 2nd prize in a scrap art competition by Ujjain Municipal Corporation.
- Achieved Madhyama Purna Certification as a Tabla Player.

# Balgovind Shanbhag

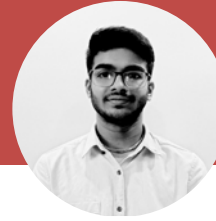

B.DES INDUSTRIAL DESIGN

## Portfolio

<https://www.behance.net/balgovindshanbhag>

## Internship

Salt.pe, Bangalore

- Worked on the app and website of Salt.pe.
- Below mentioned points have been covered for app and website -
  - Design language
  - User onboarding
  - Organization onboarding
  - Payments
  - Receipt and delivery
  - Card manager

## Professional Achievements

Silver Winner-UXplorer, YUJ Designs 2019

# Deven Kale



B.DES INDUSTRIAL DESIGN

## Portfolio

<https://www.behance.net/devenkale99>

## Internship

LIGHT-FiSH Design Studio, Auroville.

- Worked on designing customizable lifestyle products, from ideations to manufacturing details.

## Professional Achievements

Won DSKIC National Design Olympiad 2016 (senior-category)

# Divya Gupta



B.DES INDUSTRIAL DESIGN

## Portfolio

<https://www.behance.net/divyagupta29>

## Internship

Campaigntocash, Canada.

- The tasks included creating website, graphical and social media assets for the company as well as it's clients.
- The major project was to build an Influencer Marketing platform for the company's existing application which resonates the brand language of the company.

# Gaurang Agarwal



B.DES INDUSTRIAL DESIGN

## Portfolio

[http://www.behance.net/gaurang\\_agarwal](http://www.behance.net/gaurang_agarwal)

## Internship

KABBISH, Jaipur

- Handling the digital marketing and work behind uploading products on the website.

## Professional Achievements

Delegate of ALGERIA in IMUN Online Conference 4.0 - MAY 9th- 10th, 2020.

# Gauri Singh



B.DES INDUSTRIAL DESIGN

## Portfolio

<https://www.behance.net/gaurisingh05>

## Internship

Illumnus- May 2020 to August 2020.

- User research
- Optimizing existing user interface
- Designed and implemented new user interface

# Himanka Kalita



B.DES INDUSTRIAL DESIGN

## Portfolio

<https://www.behance.net/himankakalita>

## Internship

ShopX - 10i commerce services, Bangalore

- Consumer-grade UV product - UX research & analysis, CAD, Marketing (collateral)
- Industrial grade UV product range - R&D (manufacturing), CAD development
- 5+ minor projects - Digital prototyping & visual communication.

## Professional Achievements

Winner - National graphics championship (2011)  
Runner up - Toastmasters International speech contest, Area A4, (2018)

# Hritik Ramsinghani



B.DES INDUSTRIAL DESIGN

## Portfolio

<https://www.behance.net/hrdesignsb3c7b>

## Internship

Talkd, Pune

- To do the heuristic evaluation for the upcoming projects.
- Understand client requirements to design thoughtful experiences for digital products and services website, dashboard, chatbot, kiosks, and car clusters.
- I have worked on 4 Live projects from start to end.

# Janhavi Kedar



B.DES INDUSTRIAL DESIGN

## Portfolio

<https://www.behance.net/janhavia>

## Internship

Seven11 Designs, Thane

- Was exposed to design a variety of products.

# Krati Agrawal



B.DES INDUSTRIAL DESIGN

## Portfolio

<https://www.behance.net/kratiagrawal9899>

## Internship

Sattvarise Technologies, Pune.

- Was responsible for creating an AR-based educational game for age group 4-12 that teaches children Indian geography.

# Krithik Prabhakar



B.DES INDUSTRIAL DESIGN

## Portfolio

<https://www.behance.net/krithikprabhak>

## Internship

Emote Electrics, Coimbatore

- Task was to redesign the front-end of their website and improve the user experience.
- Was also required to design the TFT display of the bike from scratch and enhance the navigation of the display.

## Professional Achievements

UMC Scrap-art Competition Oct 2018 (1st Runner-up)  
Kala Ghoda Art Installation Feb 2020

# Kshitij Gangurde



B.DES INDUSTRIAL DESIGN

## Portfolio

<https://www.behance.net/kshitijgangurde2904>

## Internship

Rural Handmade, London

- Designed concepts for lifestyle products, office products, and tech accessory products using some handicraft techniques.
- Also, generated a research paper on improving techniques in various handicrafts (Paper is yet to be published).

# Kshitij Kalia



B.DES INDUSTRIAL DESIGN

## Portfolio

<https://www.behance.net/kaliaa0220>

## Internship

Escorts Ltd, Faridabad

- My 3 month internship at Escorts Ltd was a research based project.
- I gained knowledge about mechanical components used in tractors such as Hydraulics and Radiators and did Market analysis for the same.

# Manasi Parulekar



B.DES INDUSTRIAL DESIGN

## Portfolio

<https://www.behance.net/manasi20699>

## Internship

Salt.pe, Bangalore

- Was responsible for creating social media campaigns, blog infographics, paid campaigns and content building.

# Mansi Gupta



B.DES INDUSTRIAL DESIGN

## Portfolio

<https://www.behance.net/Mansiguptaf661>

## Internship

Indigo Consulting, Mumbai.

- My role was to enhance the user experience of leading private sector fintech and E-Commerce websites.
- By auditing, evaluating, wireframing, and prototyping in collaboration with the UX team.

# Mayuresh Gade



B.DES INDUSTRIAL DESIGN

## Portfolio

<http://be.net/mayureshgade36>

## Internship

Rural Handmade, London

- Worked & wrote a research paper on the topic "Identifying various Digital Methods that can be used as a platform for Rural Artisans".
- Also worked on commissioning new product designs.

# Mrunmayi Joshi



B.DES INDUSTRIAL DESIGN

## Portfolio

<https://www.behance.net/mrunmayijoshi>

## Internship

Indigo Consulting, (Publicis Group), Mumbai

- My tasks were to collaborate with the UX team and enhance digital experiences for multiple fin-tech, pharmaceutical as well as entertainment brands.
- One of the fin-tech projects, for a leading Indian brand, was built from scratch.

## Professional Achievements

Kala Ghoda Art Installation Feb 2020

# P Unnyan Kumar



B.DES INDUSTRIAL DESIGN

## Portfolio

<https://www.unnyan.com/>

## Internship

TEQZO Consulting, Bangalore

- Had an opportunity to work on the Clicksie project (client-based of Seattle, USA) with the TEQZO team.
- Worked on multiple industry live projects which included various market research, design strategy for product development and concept creation under the guidance of Shanavas MS (Director of TEQZO).

## Professional Achievements

Winner of 'Smart bag project' under ShopX  
Team lead of 'The Q'

# Palash Bakre



B.DES INDUSTRIAL DESIGN

## Portfolio

<https://www.behance.net/palashbakre>

## Internship

Odisha Design Council (ODC), Odisha

- I was responsible to design and ideate systematic packaging solutions for handicrafts produced in Odisha state.
- I was also required to conceptualize a new possible design for cyclone-resistant houses based on extensive research and analysis.

## Professional Achievements

UMC Scrap-art Competition Oct 2018 (1st Runner-up)  
Kala Ghoda Art Installation Feb 2020

# Parth Bhavsar



B.DES INDUSTRIAL DESIGN

## Portfolio

<https://www.behance.net/parthbhavsar1>

## Internship

Mindmap, Hyderabad

- Graphic Designing
- Web Designing and Bot design for Mindmap
- Information Analysis and Refining.
- Video editing and storytelling.

# Payal Sharma



B.DES INDUSTRIAL DESIGN

## Portfolio

<https://www.behance.net/gallery/87963593/Portfolio>

## Internship

Talkd, Pune

- Worked on multiple live UI/UX projects.

## Professional Achievements

Dean's list Fall'17 and Spring'18 for outstanding academic achievement at Arizona State University

# Piyush Agrawal



B.DES INDUSTRIAL DESIGN

## Portfolio

<https://www.behance.net/piyushagrawal1>

## Internship

Grau Bär Design Studio, Indore

- Jewellery structural packaging design
- KLD design
- Manufacturing & Branding

# Praduman Joshi



B.DES INDUSTRIAL DESIGN

## Portfolio

<https://www.behance.net/pradumanma4c02>

## Internship

Bigbasket, Bangalore

- Rethought their entire UI and created a Design system for the bbinstant app.

## Professional Achievements

- Kala Ghoda Art Installation Feb 2020

# Prateek Jain



B.DES INDUSTRIAL DESIGN

## Portfolio

<https://www.behance.net/prateekjain298>

## Internship

DesignFlyover Studio, Powai, Mumbai.

- Responsible for designing a 'Compressible UV Disinfection Bag' from scratch
- User analysis
- Concept generation
- CAD modelling

# R. Abhishek



B.DES INDUSTRIAL DESIGN

## Portfolio

<https://www.behance.net/RAbhishek>

## Internship

Hvantage Technologies, Indore

- I worked in phone app UI design, website UI, Digital marketing (still creatives & videos) for Social media.
- CAD modelling for their products.
- Packaging for products.
- Brochure designs for their products.

# Radhika Goyal



B.DES INDUSTRIAL DESIGN

## Portfolio

<https://www.behance.net/radhikagoyal2>

## Internship

Design pulse, Indore

- Researched on COVID-19 pandemic and then designed few products related to it.
- Designed a DIY or a product on the topic gardening.
- Carried out desk research for the products which are still in demand during COVID-19.

# Rohan Goje



B.DES INDUSTRIAL DESIGN

## Portfolio

<https://www.behance.net/rohangoje17>

## Internship

Sattvarise Technologies, Pune

- I was responsible for creating an AR based educational card game for children from age group 4-12 years.
- The game was based on Indian Geography.

# Shantanu Thorat



B.DES INDUSTRIAL DESIGN

## Portfolio

[https://www.behance.net/shantanu\\_thorat](https://www.behance.net/shantanu_thorat)

## Internship

Teqzo Consulting, Bangalore

- Worked on 4 live product and application projects.
- Design research, ideation and mapping.
- Extensive sketching and concept development.
- The design strategy and the overall development of a product including specifics, personas, and UX of the product and application.

## Professional Achievements

Silver Winner- UXplorer, YUJ Designs 2019

# Shreya Paliwal



B.DES INDUSTRIAL DESIGN

## Portfolio

<https://www.behance.net/shreyapaliwal>

## Internship

Grau Bär Design Studio, Indore

- The project focused on Designing Packaging for jewellery
- It included Primary, Secondary and Family of packaging followed by creating dieline template, tiling, product detailing and enhancing overall experience for the same.

# Soham Mohanty



B.DES INDUSTRIAL DESIGN

## Portfolio

<https://www.behance.net/sohammohanty>

## Internship

Bigbasket, Bangalore

- Assisted in designing the system for BBd and BB app, at Bigbasket

## Professional Achievements

- Winner - Lexus Design Awards India 2020
- Silver winner- YUJ Uxplorer 2019
- Runners up - best out of waste by UMC
- Rajyapuraskar - Governor of odisha

# Swarali Hindlekar



B.DES INDUSTRIAL DESIGN

## Portfolio

<https://www.behance.net/swarali-hindlekar>

## Internship

Indigo Consulting, Mumbai

- Had the opportunity to work on financial, pharmaceutical, legal, and entertainment sector projects.

## Professional Achievements

- Kala Ghoda Art Installation Feb 2020
- Ambassador of Young Designers Circle, a World Design Organization initiative.

# Tanvi Kulkarni



B.DES INDUSTRIAL DESIGN

## Portfolio

<https://www.behance.net/tanvi20kulkarni>

## Internship

BigBasket, Bangalore

- My role was to conduct design research and analysis.
- To ideate, wireframe, concept development, user interface guidelines and design system building.

# Vaibhav Sharma



B.DES INDUSTRIAL DESIGN

## Portfolio

<https://www.behance.net/vaibhavsharma2311>

## Internship

Indigo consulting, Mumbai

- My projects included gathering user requirements, designing graphic elements and building navigation components.



# Vineet Vishwakarma



**B.DES INDUSTRIAL DESIGN**

## Portfolio

<https://www.behance.net/vineetvishwak>

## Internship

Indigo Consulting - Digital Marketing Agency, Mumbai

- Worked on multiple projects which included tasks like user research, interface analysis, creating wireframes for website, mobile and application interfaces.

## Professional Achievements

- Kala Ghoda Art Installation Feb 2020

# Vishnu Ravi



**B.DES INDUSTRIAL DESIGN**

## Portfolio

<https://www.behance.net/vishnukr1>

## Internship

Rajiv Gandhi Center for Biotechnology, Trivandrum

- Designed HMI for industrial pilot machinery which was also proposed to Scigenics India.
- I was assigned to design and prototype power cutoff devices and also to assist the team in setting up product tests for UV Sterilizers.

# Yashaskar Narumanchi



**B.DES INDUSTRIAL DESIGN**

## Portfolio

<https://www.behance.net/yashaskar>

## Internship

Design Pulse, Indore

- Conducted market research on products and market segments that would grow after Covid-19.
- Conducted market research on kid's toys and what would the market share of toys be like after Covid-19.
- Developed a D.I.Y toy kit for kids of age 14 years and above mostly using bamboo.

---

# B.DES COMMUNICATION DESIGN

---

ALL THE 'PORTFOLIO LINKS' ARE HYPERLINKED

# Adithyan Shibu



B.DES COMMUNICATION DESIGN

## Portfolio

<https://adityanshibu.myportfolio.com/>

## Internship

### **Ogilvy, Gurgaon**

Creative Intern

- Worked on **BMW India**
- Packaging Design
- Logo Design
- Poster Campaigns
- Ad Campaigns
- Part of X7 India Launch Event Design Team
- Scripts for Television Commercial

# Aishwarya Tadwalkar



B.DES COMMUNICATION DESIGN

## Portfolio

<https://www.behance.net/aishwaryat>

## Internship

Indigo Consulting, Mumbai

- My role was to create social statics for numerous web series
- I developed visual elements for a website & designing carousels for various brands.

# Akash Gupta



B.DES COMMUNICATION DESIGN

## Portfolio

<https://www.behance.net/akashgupta12>

## Internship

upGrad Edutech Platform, Mumbai

- Visual identity and Visual language
- Improving visual identity keeping the motive of increasing the traffic in the website.

# Amartya Zade



B.DES COMMUNICATION DESIGN

## Portfolio

<https://www.behance.net/amartyazade>

## Internship

Illumnus Education Technologies Pvt Ltd. Pune.

Worked as a Graphic Designer and Social Media manager.

Tasks : Digital Marketing creatives to help them grow digitally across all social media platforms.

## Professional Achievements

National Award Winner in World Skills India 2018

# Amruta Kekre



B.DES COMMUNICATION DESIGN

## Portfolio

<https://www.behance.net/Amrutakekre>

## Internship

The Minimalist, Mumbai

- Daily Social Media Creatives for various brands.
- Mailer campaigns
- Learnt a skill of handling multiple clients simultaneously and manage deadlines efficiently.

# Anoushka Karnik



B.DES COMMUNICATION DESIGN

## Portfolio

<https://www.behance.net/anoushkakac82c>

## Internship

SYU Design, Mumbai

- Created complex illustrations for an organization that supports the artisans from the handloom sector
- Brand identity and website design for an online education platform
- Brand Identity and Packaging for startups
- Was actively involved in identity design and vector illustrations for an animation sequence.

# Anushka Belsare



B.DES COMMUNICATION DESIGN

## Portfolio

<https://www.behance.net/anushkabelsare>

## Internship

Amirkhan Pathan Studio, Pune

- Worked on Real Estate and Food Brands Branding | Publication | Packaging

# Avantika Bhalotiya



B.DES COMMUNICATION DESIGN

## Portfolio

<https://www.behance.net/avanthikabbf24>

## Internship

V Green Media, Hyderabad

- Social Media Creatives
- Branding and SMM for Jewellery Brand.

# Avantika Kulkarni



B.DES COMMUNICATION DESIGN

## Portfolio

<https://www.behance.net/avantikakub46b>

## Internship

Ogilvy, Mumbai

- Worked on art and copy team for strategy creation of SMC.
- Worked on television commercial scripts, digital scripts and other forms of advertising materials.
- Brands worked upon were leading brands in the fields of stationery, FMCG, Fin-Tech, pharmaceuticals.

## Professional Achievements

Finalist in NASSCOM Design4India and Finalist in Lexus Design Awards India 2020.

# Geetanjali Lal



B.DES COMMUNICATION DESIGN

## Portfolio

<https://www.behance.net/geetanjallal740>

## Internship

Studio Design Bound - Hyderabad

- User Research for UX Projects
- Social Media Creatives for Food and Beverage Brands.
- Image and logo editing and few branding compilation work.

# Harshvardhan Gaikwad



B.DES COMMUNICATION DESIGN

## Portfolio

<https://www.behance.net/gaikwadhar2925>

## Internship

SYU Design, Mumbai

- Created complex illustrations for a company which supports artisans from handloom sector.
- Was involved in logo design and visual slates for animation sequences.
- Branding and website design for an online education platform.

# Hemant Kokate



B.DES COMMUNICATION DESIGN

## Portfolio

<https://www.behance.net/hemantkokate>

## Internship

The Minimalist, Mumbai

- The work included character illustrations.
- I also worked on visual design, mailers, posters, logo design, flyers, social media posts, animated GIFs, badge design, packaging design, brochure design, testimonial design.

## Professional Achievements

Winner of regional and district level at World Skill competitions. (Graphic design technology) (2017-18)

# Jainam Sanghavi



B.DES COMMUNICATION DESIGN

## Portfolio

<https://www.behance.net/jainamrsan446b>

## Internship

3 Minds Digital, Mumbai

- Branding, Publication Design, Social media campaign, Case study Design, Presentation Design.
- Most of the projects were created from scratch and completed fulfilling their expectations.

# Mrunal Deshpande



B.DES COMMUNICATION DESIGN

## Portfolio

<https://www.behance.net/mrunald>

## Internship

ProCreator Design Agency, Navi Mumbai

- Created high-quality UI collaterals, UI graphics, complex Illustrations, and resources for their online platform.
- Was actively involved in user testing and the entire design process for ProApp.

## Professional Achievements

- Finalist in NASSCOM Design4India and
- Finalist in Lexus Design Awards India 2020

# Naman Khajanchi



B.DES COMMUNICATION DESIGN

## Portfolio

<https://www.behance.net/Namankhaja09bc>

## Internship

upGrad, Mumbai

- Adapting current trends with upGrad's brand identity for moment marketing.
- Creating relevant memes in line with upGrad's tone of communication.
- Creating blog infographics and basic animation for social media creatives.

## Professional Achievements

Creator's Award by Realme Mobiles

# Nirmiti Mantri



B.DES COMMUNICATION DESIGN

## Portfolio

<https://www.behance.net/mantrinirmiti>

## Internship

Indigo Consulting (Publicis Groupe), Mumbai

- Social media campaigns and e-commerce banners for brands like Maybelline, Newyork.
- Extensively worked on Maybelline Newyork's product shade card booklet.
- Designed logos, emailers and invites.

# Nitya Vijaywargiya



B.DES COMMUNICATION DESIGN

## Portfolio

[https://www.behance.net/nitya\\_vijaywargiya](https://www.behance.net/nitya_vijaywargiya)

## Internship

Indigo Consulting (Publicis Groupe), Mumbai

- Social media campaigns and e-commerce assets for brands like Maybelline, L'Oreal, Youtube and Bluehost.
- Extensively worked on Maybelline Newyork's product shade card booklet.
- Posters and emailers for internal events.

## Professional Achievements

Art installation at Kala Ghoda Art Festival- 2020

# Parul Jaggi



B.DES COMMUNICATION DESIGN

## Portfolio

[https://www.behance.net/paruljaggi27\\_7](https://www.behance.net/paruljaggi27_7)

## Internship

The Minimalist, Mumbai

- Created & managed a variety of creative marketing projects.
- Maintaining the brand guidelines & implementing a new design pattern for digital media marketing.
- Illustrations, creatives and animation gifs.

# Prit Gajjar



B.DES COMMUNICATION DESIGN

## Portfolio

<https://www.behance.net/pritgajjar6551>

## Internship

PULP India

- SOPs
- SMM posts
- SMM stories
- Websites UI
- Emailers
- Image retouching

# Priyasha Patade



B.DES COMMUNICATION DESIGN

## Portfolio

<https://www.behance.net/priyeshapatade>

## Internship

The Minimalist, Mumbai.

- Worked on EV Branding for an enterprise mobility business.
- Designed animated characters for a fitness club.
- Created logos, worked on testimonial designs, iconography, brochure design and SMM.
- Assisted in the Packaging Design of two brands produced by one of the largest conglomerate companies of India.

# Puja Shetty



B.DES COMMUNICATION DESIGN

## Portfolio

<https://www.behance.net/pujashetty>

## Internship

ShopX

- As a designer, I had played a major role in the product categories of FMCG, cosmetics, electronic products, and accessories.
- Also actively participated in their marketing activities, campaigns, and research.

# Purva Jhunjhunwala



B.DES COMMUNICATION DESIGN

## Portfolio

<https://www.behance.net/purvajhun09>

## Internship

SAGE Publications

- Designed book covers for 4 clients which were then published by the firm.
- Worked along with the marketing team to create social media creatives for the firm and also designed style sheets for brochures and catalogs.

# Rakshita Rastogi



B.DES COMMUNICATION DESIGN

## Portfolio

<https://www.behance.net/rakshitarastogi>

## Internship

Redtin Studio, Delhi.

- I was given an opportunity to be a part of two major projects.
- Creating a brand identity of a business consulting firm.
- Designing a brochure for their studio.

# Rushell Rose Raphael



B.DES COMMUNICATION DESIGN

## Portfolio

<http://be.net/rushellrose7039>

## Internship

ProCreator- Digital Design Agency, Mumbai

- Created high-quality UI collaterals and complex illustrations for the ProApp.
- Involved in crucial personas and User Testing for the ProApp.

# Satyadev Pius



B.DES COMMUNICATION DESIGN

## Portfolio

[https://www.behance.net/satyadev\\_pius](https://www.behance.net/satyadev_pius)

## Internship

SAGE Publications India Pvt Ltd.

- During my internship, I worked on my project titled "Animated GIFs for SAGE retail titles promotions and Magisto"
- Under the mentorship of Ms. Anupama Krishnan -Marketing Manager-Design.

# Shrawani Bohra



B.DES COMMUNICATION DESIGN

## Portfolio

<https://www.behance.net/shrawanibohraSB>

## Internship

Rivet Design Studio

- Build brand spaces and brand identity.
- Worked on Environmental Graphics.
- Publication Design - Digital brochure, Cards & Profile.
- Signage - For Covid19.

# Siddhant Joshi



B.DES COMMUNICATION DESIGN

## Portfolio

<https://www.behance.net/sidjoshi10b65b>

## Internship

The Minimalist, Mumbai

- Was a part of the 'Social Media Advertising Design Team' for leading brands in real estate, finance, academic book publishing, pharmaceutical, and med-tech domains.
- Handled Mailer campaign projects and SMC for big banking clients of the organization.

# Som Aprameya



B.DES COMMUNICATION DESIGN

## Portfolio

<https://www.behance.net/somaprameyasingh>

## Internship

Pathshala Co. Graphic Design

- Worked on specializing in daily advertisements and updates to the web page as well as social media posts.

# Suyash Jog



B.DES COMMUNICATION DESIGN

## Portfolio

<https://www.behance.net/jogsuyash>

## Internship

Untrodden labs

- Assisted in Website UI development.
- Created product renders.
- Working on a complete product launch video.

# Tanvi Bhujadi



B.DES COMMUNICATION DESIGN

## Portfolio

<https://www.behance.net/tanvibhujaja3a83>

## Internship

Minimal her

- Worked on generating illustrations and commercial graphic content for the product range.
- Worked on creating social media campaigns with the team.

## Professional Achievements

- A illustration got featured on Fila South Africa's website for the #creatorsoffila campaign.

# Tanvi Dev



B.DES COMMUNICATION DESIGN

## Portfolio

<https://www.tanvidev.com/>

## Internship

Ogilvy & Mather, Mumbai

- Worked on television commercial scripts for leading brands in the domain of FMCG, stationery, banking, pharmaceuticals and violence against women.
- Ideated and designed several advertising creatives and topical posts for brands.

## Professional Achievements

- Winner at UMC - Ujjain Municipal Corporation, 2nd position, Scrap Art Competition 2019
- Kala Ghoda Art Installation 2020

# Tanvi Kakirwar



B.DES COMMUNICATION DESIGN

## Portfolio

<https://www.behance.net/tanvikakirwar>

## Internship

PAY 1 (Ux Designer)

- Conducted user research
- Simplified the user flow of the Khata app (supply chain) for distributors and merchants.
- Reduced the user drop-off rate considerably and increased the number of users.

# Tanvi Mahambare



B.DES COMMUNICATION DESIGN

## Portfolio

<https://www.behance.net/tanvimahambare>

## Internship

Ogilvy, Mumbai

- Designed illustrations for social media and logo for a corporate activity.
- Designed a poster for a newly launched Bodywash.

## Professional Achievements

- Graduate in Bharatanatyam

# Vibhuty Gaggar



B.DES COMMUNICATION DESIGN

## Portfolio

<https://www.behance.net/vibhutygaggar>

## Internship

Brandmovers Mumbai

- Designed creatives for 6 of India's top fashion brands which were utilized for marketing and Advertising of their products and services.

## Professional Achievements

- Finalist in NSSCOM Design4India and Finalist in Lexus Design Awards India 2020

# Vidha Tripathi



B.DES COMMUNICATION DESIGN

## Portfolio

<https://www.behance.net/vidhatripathi>

## Internship

Pulp Advertising, Mumbai

- Branding,
- Social media campaigns,
- Presentation designs,
- Unit designs,
- Packaging



---

# **B.TECH COMPUTER SCIENCE & ENGINEERING**

---

ALL THE 'PORTFOLIO LINKS' ARE HYPERLINKED

# Hatim Nomani



**B.TECH COMPUTER SCIENCE & ENGINEERING**

## Portfolio

<https://hatim.nomani.tech>

## Internship

Witty Pen, Pune

- Software developer Intern.

# Ishan Shrivastava



**B.TECH COMPUTER SCIENCE & ENGINEERING**

## Portfolio

<https://www.ishans.work>

## Internship

SuperBotler, Bangalore

- There were a couple of projects, one of them was to build API(s) for different websites.
- This also included building a custom image classification solution for the backend.

# Karan Rathore



**B.TECH COMPUTER SCIENCE & ENGINEERING**

## Portfolio

<https://www.behance.net/karanrathore>

## Internship

Talspo Private Limited, Indore

- Backend and PWA developer intern.

# Kuldeep Pal



**B.TECH COMPUTER SCIENCE & ENGINEERING**

## Portfolio

<https://www.behance.net/kuldeppal>

## Internship

Peacock Solar, Gurugram

- Implemented data analysis on sales & telemarketing data.
- Programmed regression model for customer segmentation.

# Madhur Chhajed



**B.TECH COMPUTER SCIENCE & ENGINEERING**

## Portfolio

<https://www.behance.net/madhurchhajed>

## Internship

Peacock Solar, Gurugram

- As a Data Science intern, I was given different datasets from sales and telemarketing team for data cleaning, exploratory data analysis, gaining insights and documenting the result to better help the company in scheduling meeting.
- Understanding pattern for customer lead to become a potential customer.

# Manas V. Choubal



**B.TECH COMPUTER SCIENCE & ENGINEERING**

## Portfolio

<https://www.manaschoubal.me/>

## Internship

Hvantage Technologies, Indore

- Business Listing Website.
- Database management.
- Design & development (HTML, CSS, JavaScript, PHP, SQL).
- Integrated a socket based chat application.
- Fully-functional admin panel.

## Professional Achievements

Was a part of the ShopX Form XI team for developing the technology for a smart backpack.

# Manas Shukla



**B.TECH COMPUTER SCIENCE & ENGINEERING**

## Portfolio

<https://www.behance.net/manas1234820ad>

## Internship

Danalitic India Pvt. Ltd., Pune

- I was working as a data science intern at danalitic where I got an exposure on data science skills while working on projects related to Twitter sentiment analysis, COVID-19 Dashboard and AI automation.
- MLOps which was a tool to visually interact, combine, explore diverse datasets into data ready machine learning and AI application at enterprise scale.

# Manasi Bandal



**B.TECH COMPUTER SCIENCE & ENGINEERING**

## Portfolio

<https://www.behance.net/manasibandal>

## Internship

Danalitic India Pvt. Ltd., Pune

- The work was associated with Data visualization of COVID-19, social media sentiment analysis, machine learning automation, and MLOps along with predictive analysis for companies.

## Professional Achievements

- Winner at Hackathon 2019, Design-Tech fest, ChakraView at Avantika University.

# Mayank Soni



**B.TECH COMPUTER SCIENCE & ENGINEERING**

## Portfolio

<https://www.behance.net/mayanksoni>

## Internship

Danalitic India Pvt. Ltd., Pune

- The work was associated with the development of front end for two projects that are COVID-19 dashboard and Machine Learning automation web application.
- I involved processes like web scraping, data cleaning, merging, manipulation of the dataset, data preprocessing, exploration and visualization of data and Explored to provide a hassle-free experience to the user.
- Videos for the websites and transformed on paper ideas into the self-explanatory video.

# Mihir Srivastava



**B.TECH COMPUTER SCIENCE & ENGINEERING**

## Portfolio

<https://www.behance.net/mihirsrivad0dc>

## Internship

Slang Labs, Bangalore

- Developed a data-agnostic analytics dashboard.
- In it users can create custom graphs using the dimensions and aggregations or generate template graphs from the data in the back-end.

# Nikhil Jagtap



**B.TECH COMPUTER SCIENCE & ENGINEERING**

## Portfolio

<https://www.behance.net/nikhiljagtap1>

## Internship

Sobus Insight Forum, Bangalore

- Conversion of HTML website to WordPress based website.
- Added a blog section to the Sobus website.
- Sobus Zoho connect onboarding manual.

# Pranjal Jain



**B.TECH COMPUTER SCIENCE & ENGINEERING**

## Portfolio

<http://pranjaljain.ml/>

## Internship

Emote Electric, Coimbatore

- Worked as a Dev-Ops Engineer.
- Created a dynamic website for Emote Electric and used AWS cloud service to host the website and backend.

# Samit Mukherjee



**B.TECH COMPUTER SCIENCE & ENGINEERING**

## Portfolio

<https://www.samitmukherjee.com>

## Internship

### **Hvantage Technologies, Indore**

- Business Listing Website
- Database management.
- Design & development (HTML, CSS, JavaScript, PHP, SQL).
- Integrated a socket based chat application.
- Fully-functional admin panel.

## Professional Achievements

- Winner at 12-Hour Design-Tech Hackathon, ChakraView - The Design Tech Fest, Avantika University.

# Shivam Singh



**B.TECH COMPUTER SCIENCE & ENGINEERING**

## Portfolio

[https://www.behance.net/shivam\\_sing3cb2](https://www.behance.net/shivam_sing3cb2)

## Internship

### **Hvantage Technologies, Indore**

- Business Listing Website
- Database management.
- Design & development (HTML, CSS, JavaScript, PHP, SQL).
- Integrated a socket based chat application.
- Fully-functional admin panel.

# Shivam Singh Rathore



**B.TECH COMPUTER SCIENCE & ENGINEERING**

## Portfolio

<https://shivamsr.com/>

## Internship

### **Ooloi Labs, Mumbai**

- Worked on MERN stack technologies to develop optimized components for their product - Open Knowledge Platform.
- Developed solutions for personalized newsletter email system, platform search indexing.

## Professional Achievements

- Selected as Google Developer Student Club Lead for our University.

# Thomas Vadakkan



**B.TECH COMPUTER SCIENCE & ENGINEERING**

## Portfolio

<https://www.behance.net/thomasvadakkan>

## Internship

### **Emote Electric, Coimbatore**

- Website development: Made a simple informational website.
- Bike sensor interfacing: Integrated a speed sensor on a bike which uploads the data over the database.

# Vedant Khatri



**B.TECH COMPUTER SCIENCE & ENGINEERING**

## Portfolio

<https://www.behance.net/vedantkhatri>

## Internship

### **Campaigntocash, Canada**

- My major project was the development of the website, which includes UI, front end and back end.

# Yash Baranwal



**B.TECH COMPUTER SCIENCE & ENGINEERING**

## Portfolio

<https://www.behance.net/yashbaranwal>

## Internship

### **Sobus Insight Forum, Bangalore**

- Worked as a system analyst intern.

---

# **B.TECH MECHANICAL ENGINEERING**

---

ALL THE 'PORTFOLIO LINKS' ARE HYPERLINKED

# Aditya Upadhyay



**B.TECH MECHANICAL ENGINEERING**

## Portfolio

<https://www.behance.net/adityaupadhyay10>

## Internship

ThingGoSocial, New Delhi

- Ideated & designed the final production ready CAD models for the sheet metal fabrication.
- Designed 5 different sterilizing products and coordinated with different teams for final product testing.

## Professional Achievements

- Winner at ChakraView 12 hr Hackathon, Avantika University.
- Reap Benefit Solve Ninja Fellowship.
- Certificate for outstanding performance in Academics.

# Ayush Bhokare



**B.TECH MECHANICAL ENGINEERING**

## Portfolio

<https://www.behance.net/ayush1998>

## Internship

Untrodden Labs, New Delhi

- UV-C Chamber
- Automatic UV Bots (Auto & Auto+)
- These projects were designed to accomplish the purpose of sterilization.
- The task provided to me were the CAD Model Design of these products at production level.

# Vipin Yadav



**B.TECH MECHANICAL ENGINEERING**

## Portfolio

<https://www.behance.net/vipinrao169faa>

## Internship

Castex technologies Ltd, Haryana

- Worked on 3D modelling and created different components for the organization.

---

# M.DES INDUSTRIAL DESIGN

---

ALL THE 'PORTFOLIO LINKS' ARE HYPERLINKED

# Ankur Gaidhani



M.DES INDUSTRIAL DESIGN

## Portfolio

<https://www.behance.net/ankuraagni>

## Internship

Maker's Adda, Nagpur.

Worked directly with the architects through all phases of problem solving, designing, and construction phases of MakersAdda building project.

Played a part in organizing Art & Design fest 2019 connecting with more than 500 people in the field of design and technology.

# Bhaswati Banerjee



M.DES INDUSTRIAL DESIGN

## Portfolio

<https://www.behance.net/gallery/104283895/Design-portfolio-2020>

## Internship

Future Retail Ltd.

- Served as a visual merchandiser for one year for Big Bazar format.

# Ganesh Borkute



M.DES INDUSTRIAL DESIGN

## Portfolio

<https://www.behance.net/ganeshborkute>

## Internship

Maker's Adda, Nagpur

- Worked on the melghat bamboo kendra project.
- Designed the furniture and tent inspired by Meena Bazaar in the Akbar era as well as work on set design.

# Rutuja D. Bawankar



M.DES INDUSTRIAL DESIGN

## Portfolio

[https://www.behance.net/rutuja\\_bawankar](https://www.behance.net/rutuja_bawankar)

## Internship

Vaishnav Kurade constructions, Nagpur

I worked as an Interior designer for seven months.

# Shubhankit Jain



M.DES INDUSTRIAL DESIGN

## Portfolio

<https://www.behance.net/shubhankitjain>

## Internship

Phoenix Refrigeration PVT LTD, Pune

- Designed and fabricated the parking space for two-wheeler.

# Vaishnavi Urganlawar



M.DES INDUSTRIAL DESIGN

## Portfolio

<https://www.behance.net/vaishnaupganlawar>

## Internship

Design Cell, Nagpur

- Worked on architecture projects and learnt about the different aspects of designing.
- Participated in several stages of the construction and design processes.



---

# M.DES COMMUNICATION DESIGN

---

ALL THE 'PORTFOLIO LINKS' ARE HYPERLINKED

# Aditi Yadav



M.DES COMMUNICATION DESIGN

## Portfolio

<https://www.behance.net/aditiyadav6d38>

## Internship

- Have applied my Graphic Design skills in Social Media Marketing as a freelancer, for a newly formed marketing agency based in Varanasi.

## Professional Achievements

- Won 1st prize at the Cultural Fest of Sunbeam college for women, in an Art competition.

# Ashwin Kelkar



M.DES COMMUNICATION DESIGN

## Portfolio

<https://www.behance.net/ashwinmkelkar>

## Professional Achievements

- State level basketball player.
- 3 solo exhibitions of paintings, one exhibition fully sponsored by PNG art gallery Amravati.

# Harsimran Kaur



M.DES COMMUNICATION DESIGN

## Portfolio

[https://www.behance.net/harsimran\\_kaur](https://www.behance.net/harsimran_kaur)

## Internship

Sharman Spinning Mills Ludhiana (P) Ltd, Ludhiana

- Learned to work with software like Photoshop and Texce and designed different types of scarf prints using the same.

# Kriti Sinha



M.DES COMMUNICATION DESIGN

## Portfolio

<http://be.net/kritisinhaac2d>

## Internship

Rising People Welfare Society, Delhi

- I worked for 6 weeks as a Graphic Design Intern, where I designed various posters as well as social media posts as per their requirements.

## Professional Achievements

- I am serving as Technical Event Secretary in Student Council and my team was successfully able to organize Avantika University's first design- tech fest "ChakraView" in 2019.

# Raja Sidhartha Nagavalli



M.DES COMMUNICATION DESIGN

## Portfolio

<https://www.behance.net/rajasidhartha>

## Internship

Terrace Tech Labs (TTL), Bangalore

- Worked as 3D Designer for four months as a design-centric developer.
- I worked on a learning application named ANEK.
- My contribution was creating the user interface of an application.
- Furthermore, I also worked for two of their Architectural visualization projects.

EDUCATION FOR THE **NEXT GENERATION**  
TO BUILD A **BETTER WORLD**



॥ विद्ययाः भूषणते विद्याम् ॥

**avantika**  
UNIVERSITY

**Campus:** Vishwanathpuram, Lekoda Village

**Contact nos:** 98505 09366

**Email:** [placements@avantika.edu.in](mailto:placements@avantika.edu.in)

**Website:** [www.avantikauniversity.edu.in](http://www.avantikauniversity.edu.in)